

# **Ior DIGITAL LEAKAGE CLAMP TESTER**

**MCL-400IR+**

## **INSTRUCTION MANUAL**

Thank you very much for selecting our model MCL-400IR+  
Ior Leakage Clamp Tester.

Before use the instrument, read this instruction manual  
completely and familiarize yourself thoroughly with all  
functions.

Keep this instruction manual carefully to take out  
whenever you need.

MULTI MEASURING INSTRUMENTS CO.,LTD.  
Akihabara Murai Bldg. 7F, 1-26 Kanda Sakuma-cho,  
Chiyoda-ku, Tokyo, Japan, 101-0025  
TEL : +81-3-3251-7013 FAX : +81-3-3253-4278  
Home Page : <http://www.mutimic.com/>  
E-mail : [multi@multimic.com](mailto:multi@multimic.com)

## SAFETY SUMMARY

observe by all means

- To use this instrument safely, read this "SAFETY SUMMARY" carefully and apply the instrument correctly.
- The CAUTIONs and WARNINGs which appear on the following pages are stated to prevent the operator & other people from the dangers and their properties from the damages beforehand.

- △ WARNING : This symbol indicates the contents "Possibilities of the death or the serious wound can be supposed" caused from mis-operations.
- △ CAUTION : This symbol indicates the contents "Possibilities of the injury or only the material damage can be supposed" caused from mis-operations.

### ○ OPERATION ENVIRONMENT

#### △ CAUTION

- Do not use or storage this instrument under the condition of direct rays of the sun, high temperature & humidity and or condensation, as it may cause the deformation and or the isolation defect of the instrument.
- Do not use this instrument in the environment influenced by acids, alkalis, organic solutions, corrosive gas, etc.
- Do not use or storage this instrument where the mechanical vibration can be directly transmitted, as it may cause defect of the instrument.
- Do not use this instrument nearby the appliances which generate strong magnetic field and or electric field, as it may cause mis-movement of the instrument.
- This instrument does not have the water / dust-proof structure. Do not use this instrument in the environment with a lot of dust and drops of water, as it may cause defect of the instrument.

### ○ OPERATION CONDITION & CONNECTION

#### △ WARNING

##### POSSIBLE ELECTRICAL SHOCK

- This instrument is for the use of low voltage circuit.  
Do not make measurements of power lines carrying more than AC 500V.  
Before use, check and confirm the voltage of circuit to be measured.
- Apply only the coated cables and do not clamp bare cables.

##### POSSIBLE ELECTRICAL SHOCK OR ACCIDENT

- Do not handle the instrument in the rain, at humid place, with a drop of water and or with wet hands.
- Do not use the instrument if the CT or CT case are damaged and if something is wrong with the CT cables.
- If excessive current is applied to the CT, the instrument will be heated and damaged. Use the CT according to the rating current.

## 1. GENERAL

Generally, leakage current clamp testers are used to supervise the insulated conditions in AC low voltage circuit. Those leakage clamp testers can measure the leakage current of grounding line without cutting off the electricity of low voltage circuit on live power

condition.

Nowadays, however, many harmonics and high-frequency currents are contained to leakage current of grounding line due to an increase in high-frequency electric appliances with inverter, etc. and the measured values by different instruments are not same even at the same measuring point.

Also, leakage current contains the resistive component ( $I_{or}$ ) which flows to the ground by insulation resistance and the capacitive component ( $I_{oc}$ ) which flows by electrostatic capacity. The actual insulation deterioration is caused by  $I_{or}$  but normal leakage clamp testers cannot judge what kind of leakage current is flowing.

Under the circumstances, there are two kinds of instruments :

- (1)  $I_{gr}$  measuring apparatus with low frequency injection method.
- (2)  $I_{or}$  measuring apparatus with simplified effective method.

In the low frequency injection method, a certain frequency different from 50/60Hz is piled up by the injection transformer and then, the in-phase current is extracted from the following current. This apparatus is inconvenient to carry and is very expensive.

On the other hand, in the simplified effective method,  $I_{or}$  is measured by extracting the in-phase component from leakage current based on the voltage phase. This method cannot detect the insulation condition of grounding phase and it is getting difficult to take the voltage phase in recent transformation facilities and in the circuit of 3 phase/3 wires, it is not reliable due to the error caused from unbalance capacitance to the earth.

Our newly developed  $I_{or}$  clamp tester does not need the voltage input and can measure  $I_{or}$  values of the grounding line as well as the lines of feeder simply by clamping CT. Model MCL-400IR+ is the first and epoch-making leakage clamp tester.

## 2. PRINCIPLE

When the loading apparatus are working, the 3rd, 5th, 7th & 9th harmonics occur in the loading current due to the characteristics of rectification circuit inside of the load and or

of magnetic materials. Among these harmonic currents, the 3rd and 9th harmonic currents flow in the secondary windings of delta connected transformer as a circulating current due to the star-delta connection of high & low voltage transformers and they hardly appear at the output terminals of transformers.

On the other hand, the 5th and 7th harmonic currents appear at the high voltage side as a voltage drop. At the high voltage side, the voltage drop from other power users will be added and therefore, the terminal voltage contains harmonics will appear at the low voltage side of unloading transformer.

The ratio of the 5th and 7th harmonic voltage at the low voltage side influenced from the high voltage lines is almost fixed. Consequently, the compositions of the 5th and 7th harmonic currents flowing on the grounding lines connected with transformers will change according to the ratio of capacitance and insulation resistance in the circuit.

Also, when the circuit is getting longer, the fundamental composition will increase and the circuit inductance will get bigger and then, the ratio of the 5th and 7th harmonic currents flowing on the grounding lines will change, too.

Thereof, the resistive leakage current ( $I_{or}$ ) value can be detected by measuring the fundamental, the 5th and 7th harmonic currents flowing on the grounding line and by

seeking for coefficient from the ratio of the 5th and 7th harmonic current and the value of fundamental composition and then, by multiplying this coefficient to the fundamental leakage current.

### 3. SPECIFICATIONS

#### **3-1 GENERAL SPECS.**

##### **1)CT Part**

Inside Diameter : 40mm  
 Influence of External Magnetic Field : less than 5mA (nearby 100A conductor)  
 Withstanding Voltage : AC 2200V, 1 minute

##### **2)Measuring Part**

Measuring Function: AC Line Current, Leakage Current (Io), Resistive Leakage Current (Ior), Harmonics Current (Fundamental, 3rd, 5th, 7th, 11th, 13th, AC Voltage.

Measuring Method : CT Clamp-on Method

Measuring Range : AC Current 0-40mA/400mA/4A/40A/300A (50/60Hz)  
 AC Voltage 0-500V (50/60Hz)

Range Selection : Rotary Switch

Input Frequency : 45-60Hz

AC Conversion : RMS Detection Method

A/D Conversion : Double Integration Method

Display : 3 3/4 digit LCD, max. reading of 4000

Sampling Rate : 2 times/second (in case of Ior, one time/six seconds)

Over Indication : "OL" on the display

Low Battery Indication : "🔋" sign on the display

Auto Power Off : Approx. 10 minutes after the final key operation

Data Hold Function : "DH" mark on the display

Ior Switch : by pressing this switch, Ior value will be displayed.  
 (by pressing once again, Io value will be displayed).

Harmonic Switch : by pressing this switch, fundamental, 3rd, 5th, 7th, 11th, 13th, harmonics current value can be seen on the display in order.

Power Supply : AAA battery, LR03) x3

Power Consumption : Approx. 4.5mA (Approx.60 hours by continuous use)

Operating Circuit Voltage : Less than 500V AC

Operating Temperature : 0~40°C, less than 80%RH, without condensation

Storage Temperature : -10~60°C, less than 70%RH, without condensation

Dimensions & Weight : 70(W)x223(H)x34(D)mm, Approx. 440gs (including batteries)

Accessories : Carrying Case.....1, Instruction Manual.....1  
 Batteries.....3 (installed into the instrument)

#### **3-2 ELECTRICAL CHARACTERIC (23°C±5°C, less than 80%RH)**

Range	Resolution	Accuracy
AC40mA	0.01mA	± 1%rdg ± 8dgt
AC400mA	0.1mA	
AC4A	0.001A	
AC40A	0.01A	
AC300A	0.1A	± 1%rdg ± 1%FS
AC500V	0.1V	± 1%rdg ± 8dgt

## **Harmonic Current and Voltage**

(Fundamental, 3rd, 5th, 7th, 11th, 13th)

① Detection Method : Automatic Synchronous Filter

② Accuracy

Fundamental, 3rd, 5th, 7th :  $1\% \pm 5\text{dgt} \pm \text{AC Current/Voltage accuracy}$

11th, 13th :  $2\% \pm 5\text{dgt} \pm \text{AC Current/Voltage accuracy}$

③ Minimum Fundamental Input : more than 2% of full scale in each range

## **Resistive Leakage Current (I<sub>or</sub>)**

By formulas of fundamental, 5th and 7th harmonics current.

Caution (1): If the measured fundamental current and the 5th / 7th harmonic current value on site are different from the general ratio, it may not be possible to display the accurate I<sub>or</sub> value.

Caution (2): This measuring instrument also determines the insulation deterioration of the ground phase. When the insulation deterioration of the ground phase is detected, Appears and flashes "-" on the LCD.

## **4 . OPERATION**

### **4-1 NAME OF PARTS & EXPLANATION**

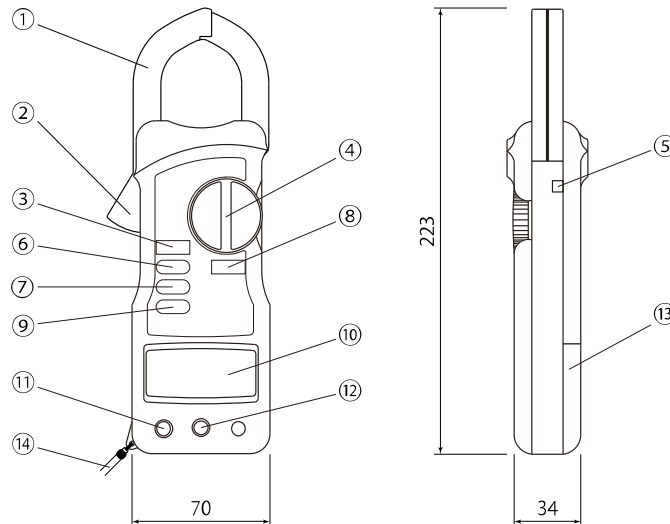

- |                                 |   |
|---------------------------------|---|
| ① Clamp CT                      | : Sensor for detection of current   |
| ② Open/Close Lever              | : By pushing this lever, CT will open.  |
| ③ Power On/Off Switch           | : By press one time, power will be "on" and the displayed value will be I <sub>o</sub> at the selected range. The setting of circuit is "1 φ" and "1 φ /I <sub>r</sub> " is lightning. By press again, power will be "off". (Power will be "off" automatically approx. 10 minutes after final key operation). |
| ④ Range Switch                  | : Manual range switch for the selection of current 40mA, 400mA, 4A, 40A, 300A and voltage 500V.   |
| ⑤ Data Hold Switch              | : By press one time, "DH" sign will be displayed on LCD and the displayed value will be held. By press once again, this function will be released.  |
| ⑥ I <sub>or</sub> SELECT Switch | : To select the circuit to be measured (single phase or three phase). By press one time, the display will be changed("1 φ" is for single phase and "△" is for three phase).   |
| ⑦ Harmonics Switch              | : At the measurement of I <sub>o</sub> current or voltage, "Harmonic No.1" mark will be displayed on LCD by press this switch one time (the value is fundamental harmonics current).  |

By press once again, "No.3" mark will be displayed for 3<sup>rd</sup> harmonics current. By pressing one time in order, the display will be become as under:

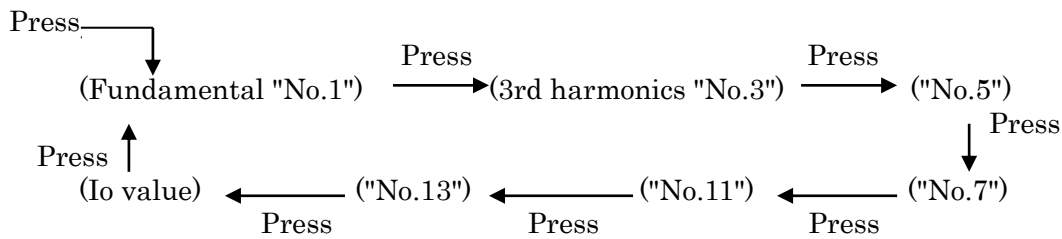

- ⑧ NOT AUTO POWER OFF SWITCH : By press one time on power-on condition, the auto power off function will be released and "Auto POWER off" sign will disappear on LCD. By press again, the auto power function will recover.
- ⑨ Ior Switch : By press this switch, "Ior" sign will appear on LCD and Ior value will be displayed. After press this switch, the calculation will start and "Wait!!" mark is lightening on the display until the calculation had been finished. After that, Ior value will be displayed. The displayed value before calculation is of the last time measurement.  
By press once again, the mode will become Io again. In case of the range switch at voltage, pressing of this switch is of no effect.
- ⑩ LCD Display :Displays of measured values , harmonics numbers, unit, battery condition, etc.
- ⑪ 500V Terminal : Insert test lead at the measurement of line voltage.
- ⑫ COM Terminal : Use for voltage measurement
- ⑬ Battery Cover : Remove this cover for the replacement of batteries.
- ⑭ Hand Strap : Wear the strap on the wrist during the measurement to avoid slip down of the instrument.

#### 4-2 OPERATION PROCEDURE

- For the safety use, strictly obey contents of CAUTION & WARNING stated in this manual.

#### ▲ MEASUREMENT OF LINE CURRENT

- 1) Set the power switch "ON".
- 2) Set the range switch to the appropriate range to be measured. (Select bigger range than the expected current value to be measured).
- 3) Open CT part and clamp it to the conductor (one wire) to be measured. Close CT completely.
- 4) Read the displayed value (in case of over range, the display will show "OL").

In case of the place where the displayed value can hardly read, use data hold function. When "DH" sign is lightening on the display, this function is effective.

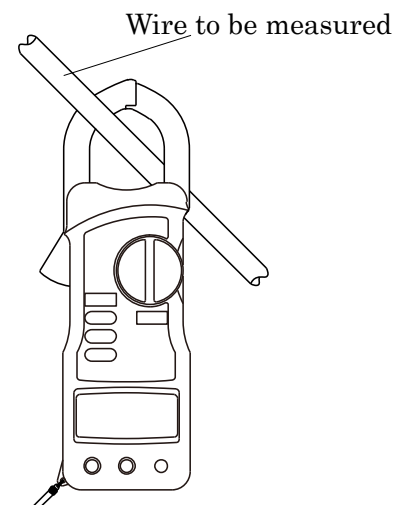

Note: Clamp CT to one wire. In case of clamping CT to parallel vinyl wire, etc. in a lump, cannot measure the line current.

## ▲ MEASUREMENT OF LEAKAGE CURRENT

- 1) Measurement for leakage current of grounding line  
Same procedure as for the measurement of line current.
- 2) Except for grounding line:  
The operation is same as for the measurement of line current but clamp CT to two wires together in case of single phase and to three or four wires together in case of three phase/three or four wires.

## ▲ MEASUREMENT OF HARMONICS CURRENT

- 1) Set the power switch "ON".
- 2) Set the range switch to the appropriate range to be measured  
(Select bigger range than the expected current value).
- 3) Open CT part and clamp it to the conductor (one wire) to be measured.  
Close CT completely. (In case of leakage current measurement, refer to "MEASUREMENT OF LEAKAGE CURRENT").
- 4) While reading the displayed value, set the range to the most appropriate one.  
(Take care of the display not to become "OL").
- 5) By pressing "HARMONICS" switch, measure each harmonics current.

## ▲ MEASUREMENT OF RESISTIVE CURRENT (I<sub>or</sub>)

(At the grounding line)

- 1) Set the power switch "ON".
- 2) By "I<sub>or</sub> SELECT" switch, set the circuit condition to Single Phase (1  $\phi$  /I<sub>r</sub>) or Three Phase ( $\Delta$ /I<sub>r</sub>).
- 3) Set the range switch to the appropriate range to be measured.  
(Select bigger range than the expected current value).
- 4) Open CT part and clamp it to the grounding line to be measured. Close CT completely.
- 5) While reading the displayed value, set the range to the most appropriate one.  
(If you can locate the instrument to the direction less influence of external magnetic field, you can make measurement more accurately).
- 6) Press "I<sub>or</sub>" switch one time. After approx. 6 seconds, the first I<sub>or</sub> value will be displayed. (Take average value of several times). By press "I<sub>or</sub>" switch once again, the mode will return to I<sub>o</sub> current measurement.

(Except for the grounding line)

- In case of single phase/two or three wires, clamp CT to two wires or three wires together. Setting of circuit is "1  $\phi$  /I<sub>r</sub>" by I<sub>or</sub> SELECT switch.
- In case of three phase/three or four wires, clamp CT to three or four wires all together. Setting of circuit is " $\Delta$ /I<sub>r</sub>".
- The operation procedure is same as for leakage current of grounding line.

## Note

- Do not mistake to set the circuit condition in case of I<sub>or</sub> measurement
- In case of harmonics current and I<sub>or</sub> current measurements, cannot detect the values unless the fundamental components (50/60Hz) are inputted more than 2% of full scale of each range.
- Do not change the range according to the values of harmonics current. It may cause errors.
- By Auto Power Off function, the power will get off automatically approx. 10 minutes after the final key operation.
- When "⚡" sign has appeared on the display during the use, it shows the

batteries are exhausted. Change the batteries to the new ones immediately.

- If the measured fundamental current and the 5th / 7th harmonic current value on site are different from the general ratio, it may not be possible to display the accurate Ior value.
- This measuring instrument also determines the insulation deterioration of the ground phase. When the insulation deterioration of the ground phase is detected, Appears and flashes "-" on the LCD.

This part flashes

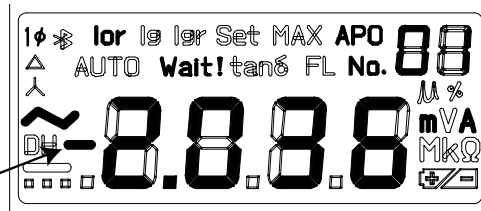

#### ▲ MEASUREMENT OF VOLTAGE (500V Range)

- 1) Set the power switch "ON".
- 2) Set the range switch to "500V".
- 3) Insert the test leads to the terminals of "500V" and "COM".
- 4) Apply the tips of test leads to the measuring points.
- 5) Read the displayed value.

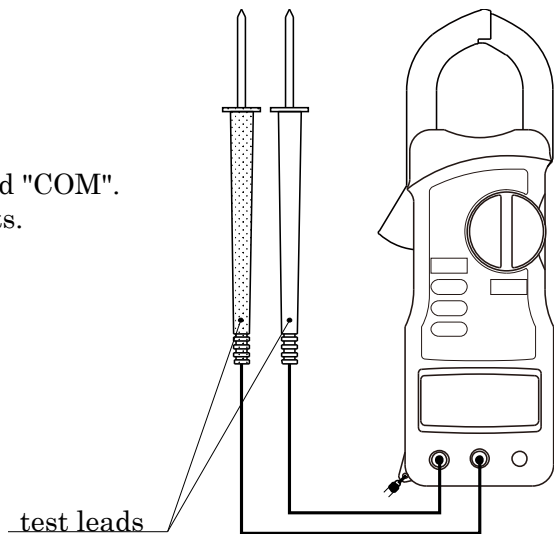

#### ▲ MEASUREMENT OF HARMONICS VOLTAGE

Refer to the operation of "MEASUREMENT OF HARMONICS CURRENT"  
But the measuring method is same as "MEASUREMENT OF VOLTAGE".

#### △ WARNING

##### **It may cause electric shock**

- Check if there is a damage on the insulated coating of test leads before use, as test leads are articles of consumption.

##### **It may cause burning damage and burn**

- Connect test leads firmly. It may cause spark in case of mistaking connection.

### 5 . CHANGE OF BATTERIES

#### △ WARNING

##### **It may cause electric shock and hazard**

- Do not replace the batteries with clamping CT to the electric conductors or during voltage measurement.
- Do not use the instrument, keeping the battery cover off.



## △ CAUTION

### It may cause damage to the instrument

- In case of not using the instrument for a long period, keep it without batteries installed. It may cause liquid leakage of batteries and may cause the damage to the instrument.
- When the batteries get exhausted and voltage is getting below than the operation Voltage, 「」 sign will appear on the display. Change the batteries without delay.
- Do not mix up the new & old batteries or different kinds of batteries to use.

### How to replace the batteries

- Remove the screw of battery cover on the back side of instrument by ⊕ driver.
- Take out three exhausted batteries.
- Confirm polarity position and install new batteries.
- Replace the battery cover and tighten the screw firmly.

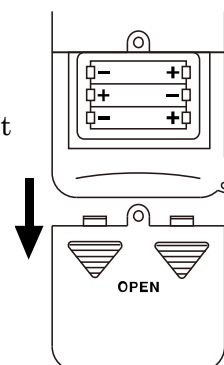

## 6. REPAIR SERVICE

When requesting for repair service, please bring the instrument directly to the dealer where you bought.

When mailing the instrument, always pack it in its original or equivalent.

Packing materials to avoid any damage during the transportation and also put together with documents showing your name, address, phone number and defect point. This measuring instrument is used for calibration by the standard current / voltage generator. However, the Ior current cannot be calibrated because it is calculated using the 5th / 7th harmonics current.

If the normal current measurement (measurement of load current) meets the standard, the Ior current value is also fine.

## 7. WARRANTY

This instrument is sent out from our factory after the sufficient internal inspections but if you find any defect due to the fault in our workmanship or the original parts, please contact the dealer where you bought the instrument.

The warranty period is 15 months from the date of purchase and the instrument shall be repaired at free of charge, provided that we judge the cause of defect is obviously resulted from our responsibility.

### GURANTEE REGULATIONS

1. This instrument is warranted for the operation under normal use for 15 months from the date of purchase.
2. This warranty does not cover the following defects:
  - a. Defect caused from the improper use and operation.
  - b. Defect caused from the use, operation and storage beyond the original specifications, designs and conditions.
  - c. Defect caused from the renovations or repairs done by someone else than us or our representatives.
  - d. Defect not caused from our responsibilities.